

Detail "A" - no scale
Form board/ extension detail

Cut 20 form boards with inside measurement of 75 1/8". Lay them out and strap them as you go. Each end is 9°. Layout extensions

Pour piers and slab first with rebar running through the form boards where the extension(s) will be.

We prefer piers when positioned at every vertice. 12" to 16" dia., as deep as you can go. Engineering fact - piers hold better!

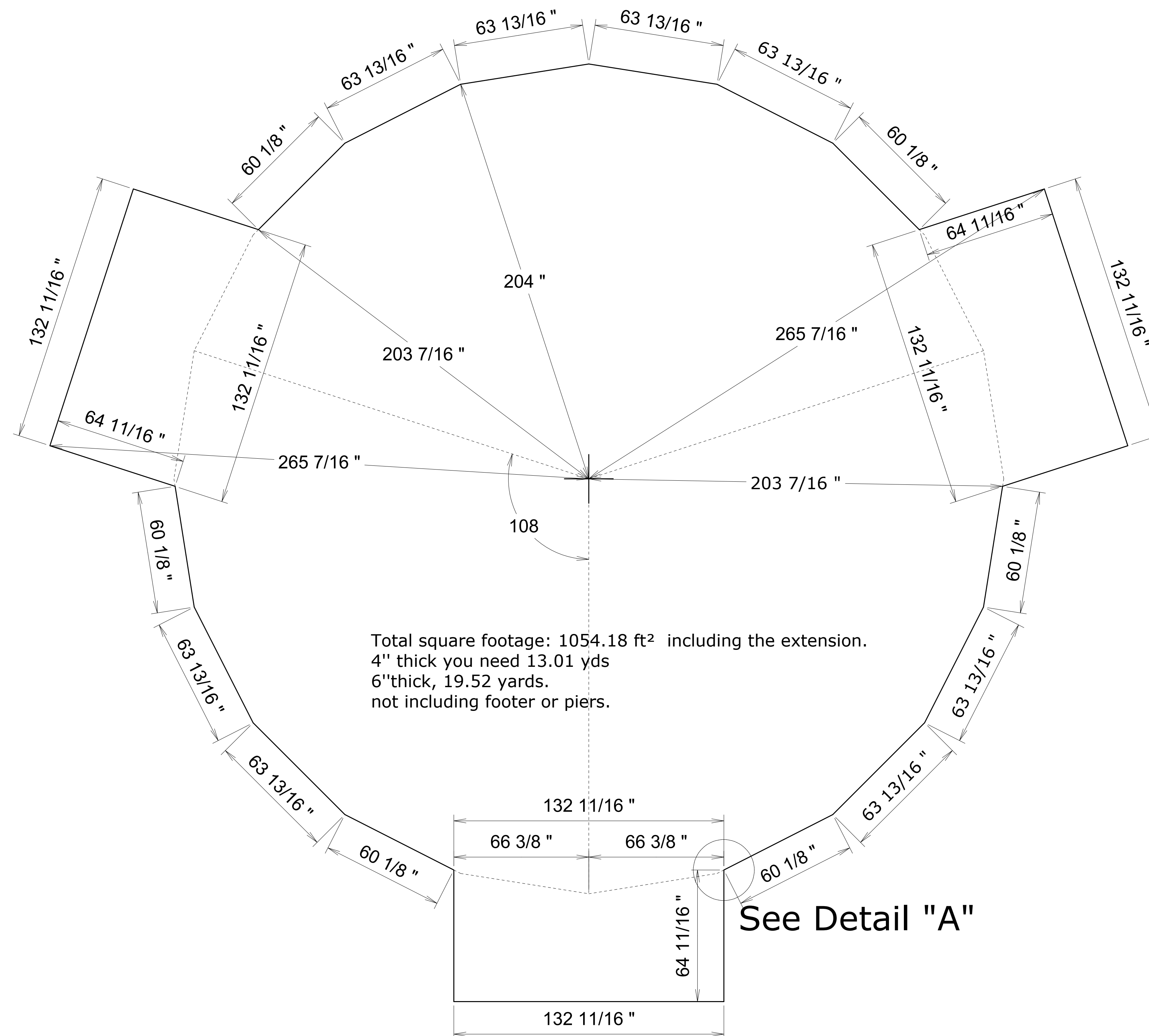

Total square footage: 1054.18 ft² including the extension.
4" thick you need 13.01 yds
6"thick, 19.52 yards.
not including footer or piers.

See Detail "A"

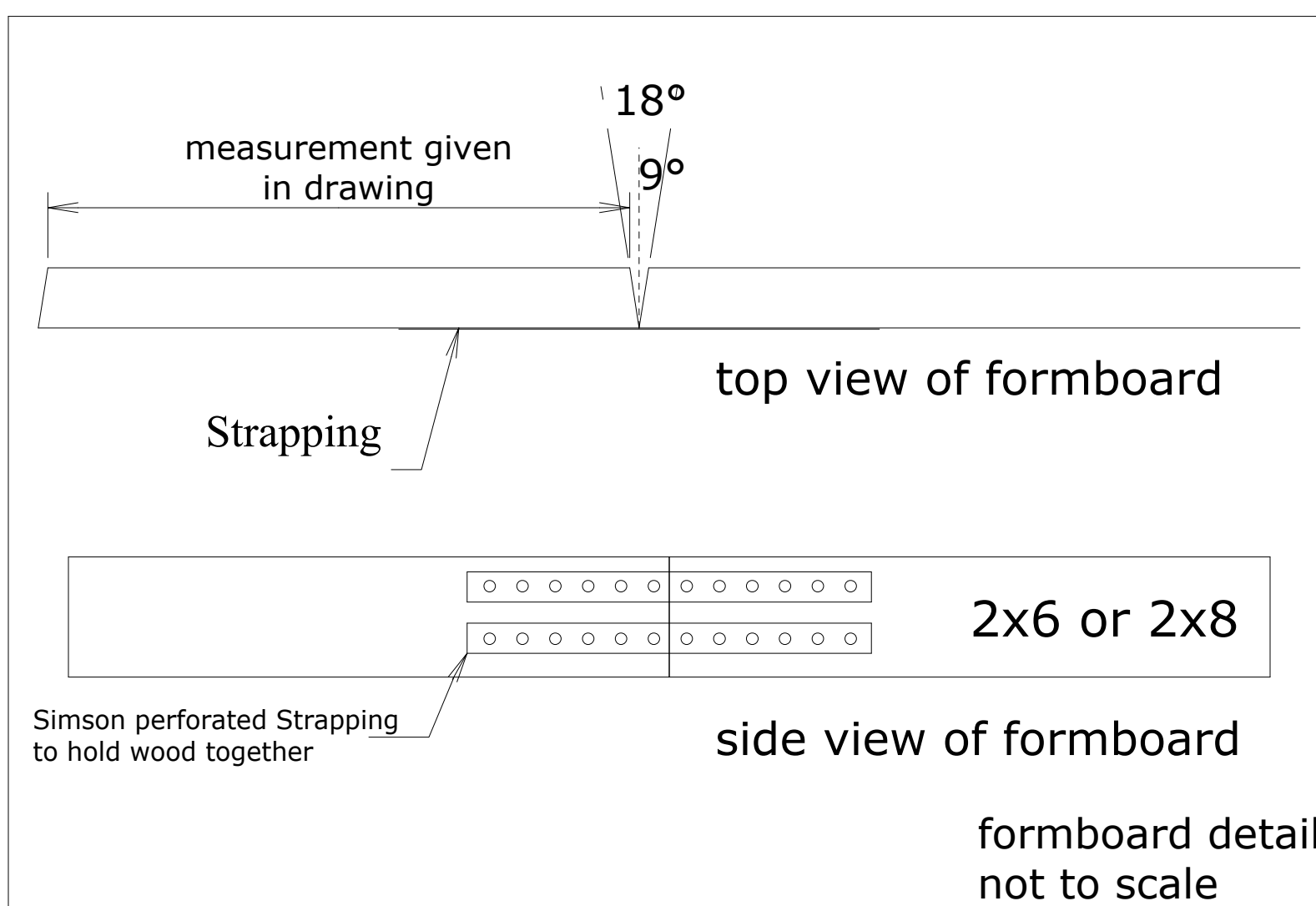

formboard detail
not to scale

Drawing scale reference
144" or 12ft
4.5 inches

GoodKarmaDomes.com		Date:	08/30/06
Scale:	3/8" = 1'	Drawn By:	T. Swaim
34ft Dome - 2x4 Framing - 3/4" decking			